

ARTIKAL
Item

JM31401

Uzidna baterija za lavabo sa izlivom
Concealed basin mixer with spout

SLIKA PROIZVODA
Product picture



TEHNIČKA SKICA
Technical draft

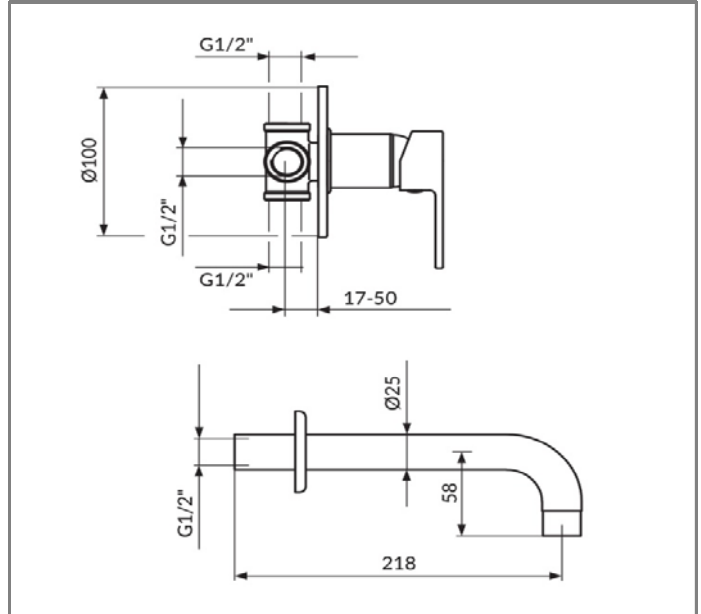

TEHNIČKI PODACI

Jednoručna baterija
Montaža u zidu
Klasa protoka Z - 7 lit/min
NEOPERL® PERLATOR® HONEYCOMB
Keramički mešač KEROX® 35 HWS
Hromirana rozeta u ravni sa zidom
Fiksni izliv L. 230mm

TECHNICAL DETAILS

Single lever mixer
Built-in wall
Flow class Z - 7 lit/min
NEOPERL® PERLATOR® HONEYCOMB
Ceramic cartridge KEROX® 35 HWS
Chromed minimalistic rossete
Fixed spout L. 230mm

RADNI USLOVI

Maksimalni radni pritisak: 5 bar
Preporučeni radni pritisak: 3 bar
Minimalni radni pritisak: 1 bar
Maksimalna dozvoljena temperatura: 80°C
Preporučena temperatura vode: 60°C

WORKING CONDITIONS

Max. working pressure : 5 bar
Suggested working pressure : 3 bar
Min. working pressure : 1 bar
Max. working temperature : 80°C
Suggested max. water temperature : 60°C

www.rosan.rs

Srbija, 24420 Kanjiža, Dušana Popovića 10.

tel.+381 24-876-744 fax +381 24-876-756, info@rosan.rs

MISTIQE