

VOLUME (l)
VOLUMEN (l)

MAX. LOAD (kg)
MAX. BELASTUNG (kg)

FLOOR LOAD (kg/m²)
BODENBELASTUNG (kg/m²)

205

370

310

- - Spot for el. cable 3×2.5mm², length approx. 1m
- Platz Stromkabel 3 × 2,5 mm², Länge cca. 1 m
- - Spot for el. cable 1×6mm² for earthing, length approx. 1.5m
- Platz Stromkabel 1 × 6 mm² für Erdung, Länge cca. 1,5 m
- - Drain spot Ø 50mm
- Abflussplatz Ø 50 mm
- ▣ - Panel - option
- Möglichkeit - Schürze

**INSTALLATION RECOMMENDATION
MONTAGEEMPFEHLUNG**

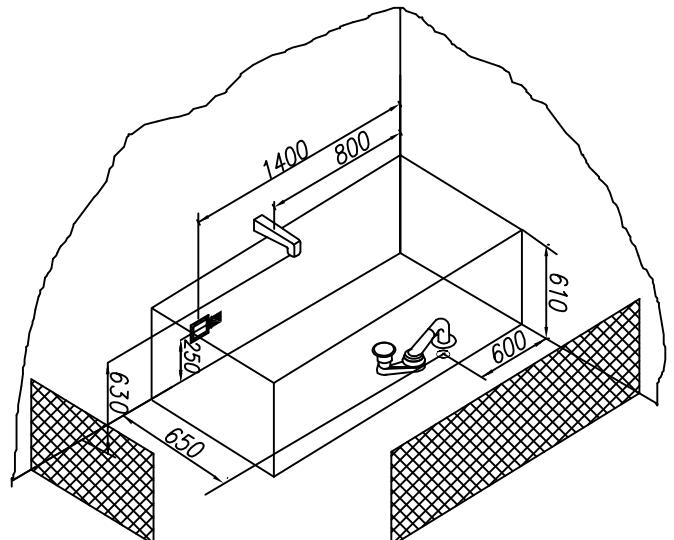

Recommended overflow set Vorgeschlagene Überlaufgarnitur	PAL 650
Recommendations for the installation of bathtub without panel Empfehlungen für die Montage von Badewannen ohne Schürze	Nr. MK 03
Recommendations for the installation of bathtub with panel Empfehlungen für die Montage von Badewannen mit Schürze	Nr. MK 01
Option of the built-in bathtub base Möglichkeit des Sockels für die Badewannen ohne Schürze	Nr. MK 05 PKK 501
Option of the bathtub base with panel Möglichkeit des Sockels für die Badewannen mit Schürze	Nr. MK 12 CM 160-170

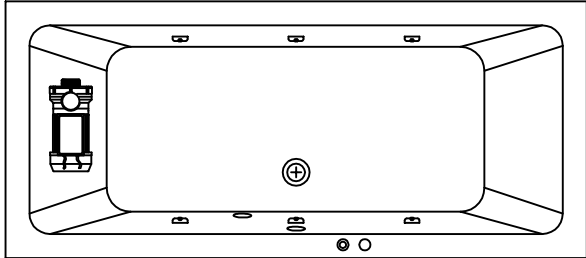
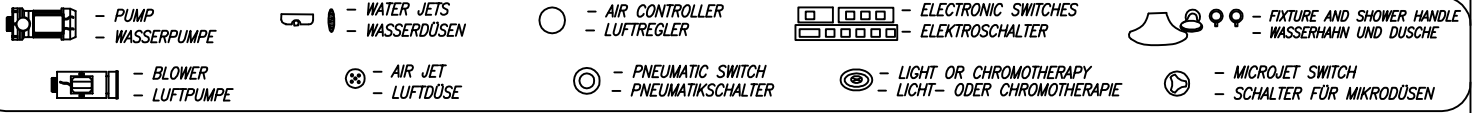

WATER MASSAGE SYSTEM 1 WASSERMASSESYSTEM 1

- | | |
|--------------------|-------------------------|
| - PUMP P=800W | - WASSERPUMPE P = 800 W |
| - PNEUMATIC SWITCH | - PNEUMATIKSCHALTER |
| - AIR CONTROLLER | - LUFTREGLER |
| - 6 WATER JETS | - 6 WASSERDÜSEN |

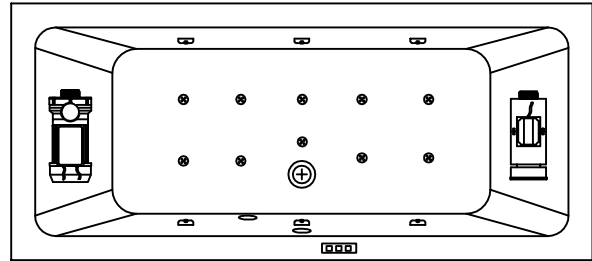

WATER AND AIR MASSAGE SYSTEM

- PUMP P=800W
- BLOWER P=800W
- ELECTRONIC SWITCH
- 6 SUPER WATER JETS
- 10 AIR JETS
- AIR REGULATOR

WASSER UND LUFT MASSAGESYSTEM

- WASSERPUMPE P = 800 W
- LUFTPUMPE P = 800 W
- ELEKTROSCHALTER
- 6 SUPER-WASSERDÜSEN
- 10 LUFTDÜSEN
- LUFTREGLER

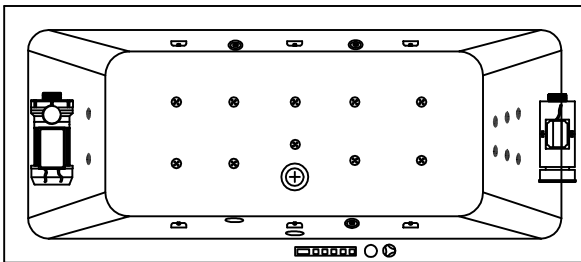

VITAL MASSAGE SYSTEM

- PUMP P=1250W
- BLOWER P=800W
- HEATER P=1500W
- ELECTRONIC SWITCH
- AIR CONTROLLER
- 6 SUPER WATER JETS
- 10 AIR JETS
- OZONE FOR DISINFECTION
- CHROMOTHERAPY
- 6 MICROJETS FOR BACK
- 2 MICROJETS FOR FEET

VITAL MASSESYSTEM

- WASSERPUMPE P = 1250 W
- LUFTPUMPE P = 800 W
- HEIZKÖRPER P = 1500 W
- ELEKTROSCHALTER
- LUFTREGLER
- 6 SUPER WASSERDÜSEN
- 10 LUFTDÜSEN
- OZON FÜR DESINFEKTION
- CHROMOTHERAPIE
- 6 MIKRODÜSEN FÜR RÜCKEN
- 2 MIKRODÜSEN FÜR FÜSSE

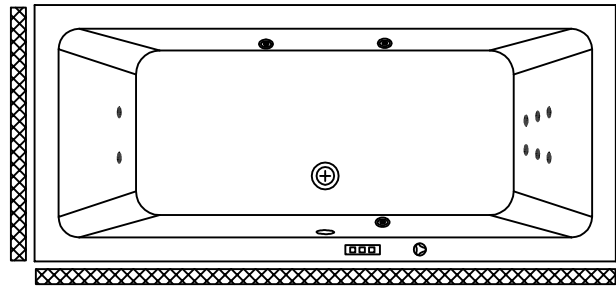

- OPTION 6 MICROJETS P=1250W



- OPTION TWO ADDITIONAL MICROJETS

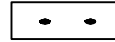

- OPTION CHROMOTHERAPY



- OPTION PANEL FOR BATHTUB



- MÖGLICHKEIT MIKRODÜSEN 6 P = 1250 W

- MÖGLICHKEIT ZWEI ZUSÄTZLICHE MIKRODÜSEN

- MÖGLICHKEIT CHROMOTHERAPIE

- OPTION SHÜRZE FÜR BADEWANNE